

0

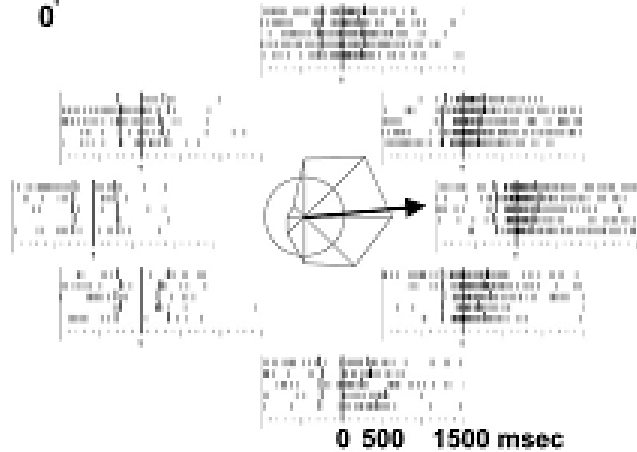

Central

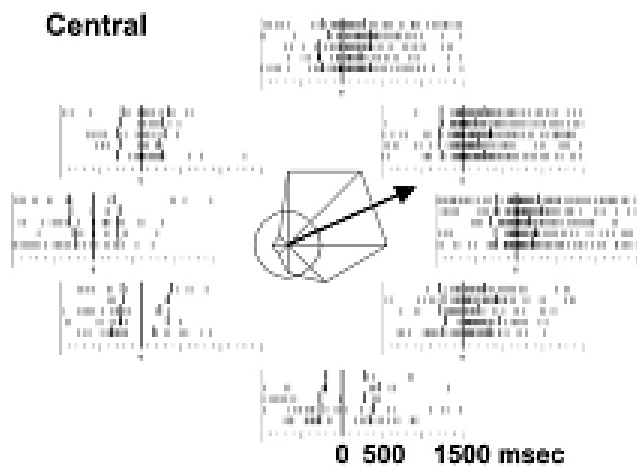

180

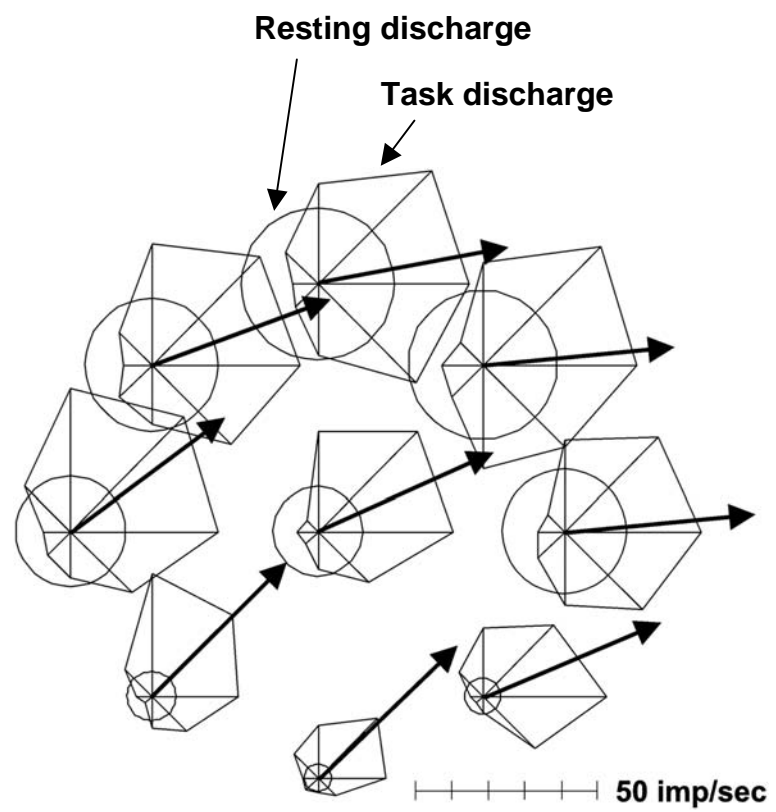
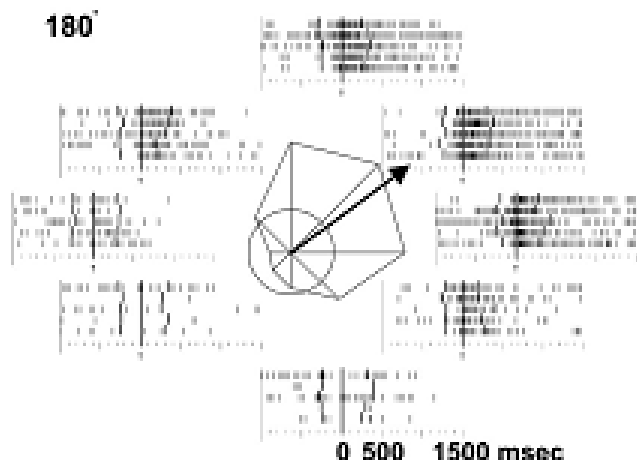

1. Although no movement occurred, the cell showed clear modulation in activity.
2. Activity showed directional selectivity.
3. The **preferred direction** for the torque depended on initial hand location, as did the amplitude of the cell's tuning for torque direction

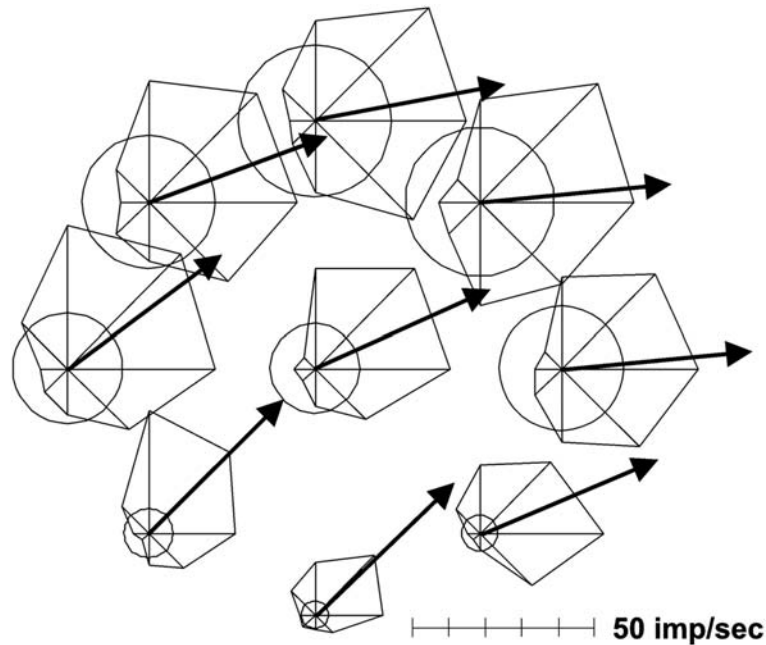

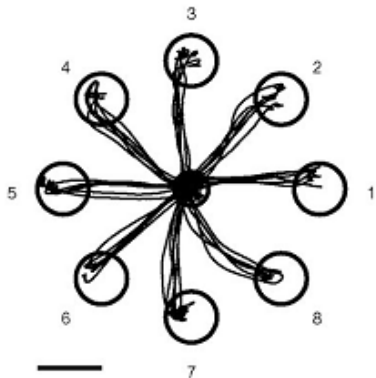
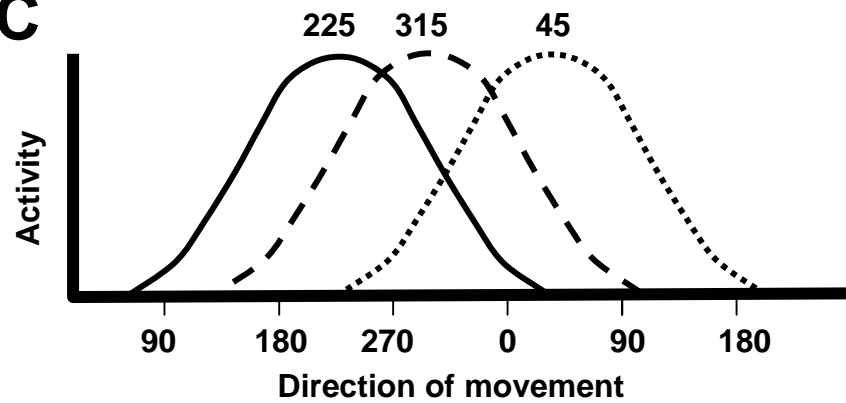
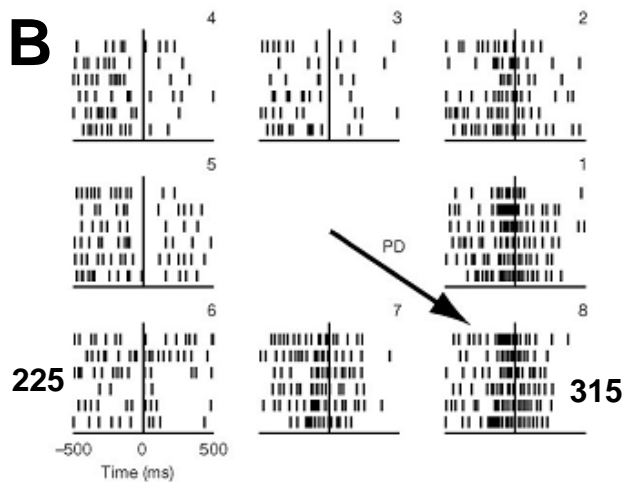
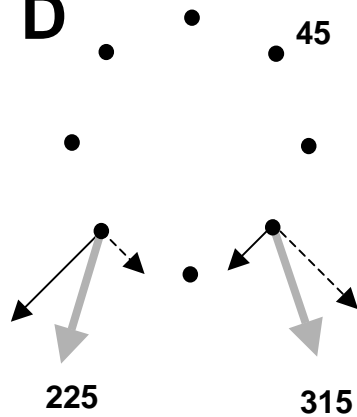
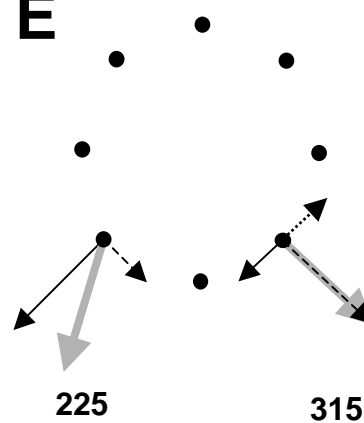
A**C****B****D****E**

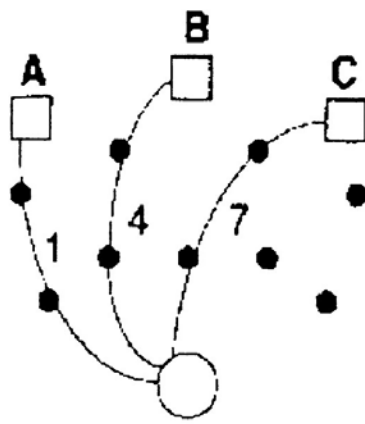

CLOCKWISE
ARCS

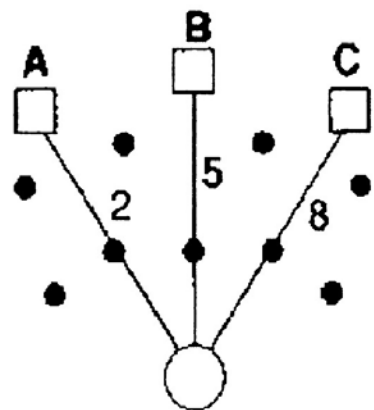

STRAIGHT
LINES

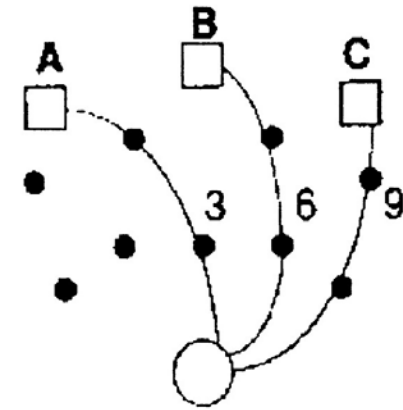

COUNTER-CLOCKWISE
ARCS

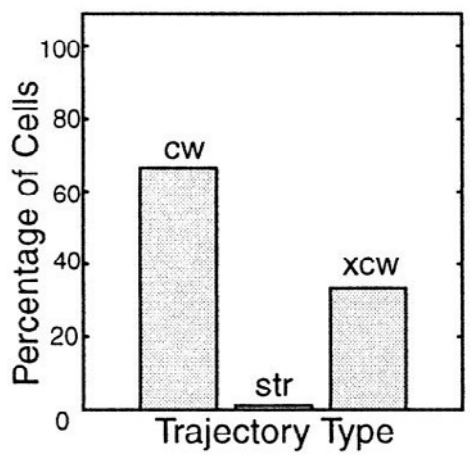

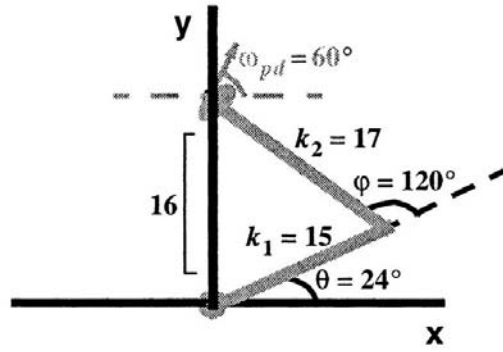

Cartesian Spatial

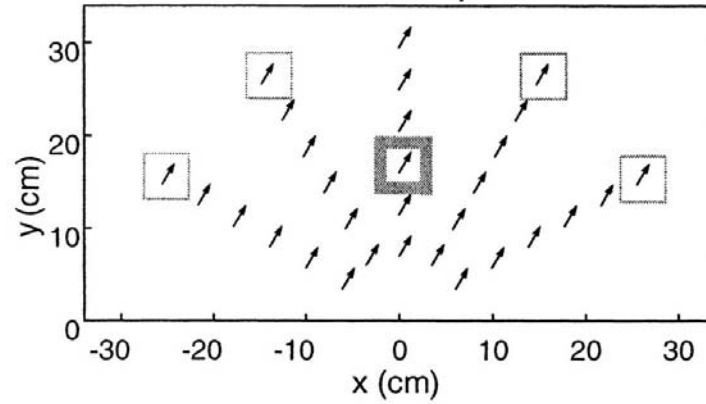

Joint Angle

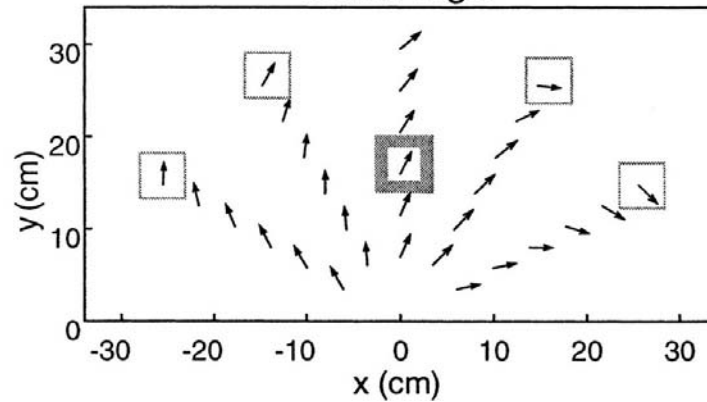

DATA

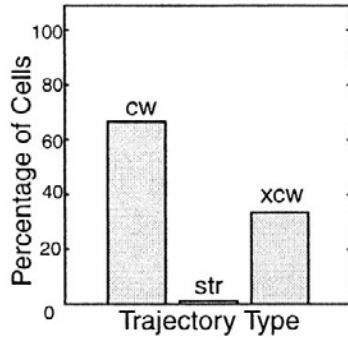

SIMULATIONS

